

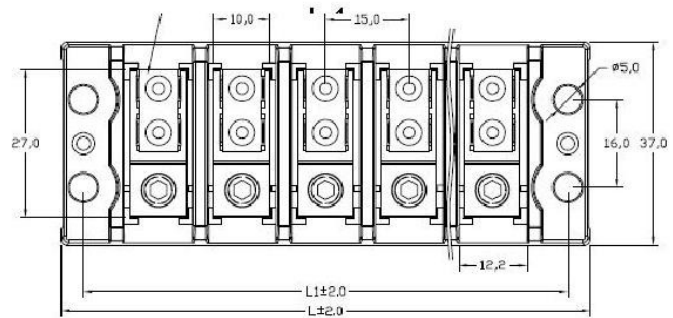

POWER DISTRIBUTION TERMINAL BLOCKS (TGP-050)

(TGP-050), A Type

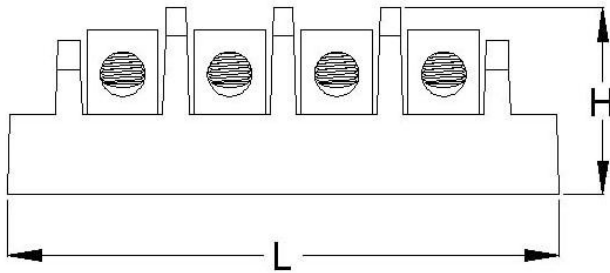

Product	TGP-050-02A	TGP-050-03A	TGP-050-04A	TGP-050-05A
---------	-------------	-------------	-------------	-------------

Specifications







Total Length (L) [mm]	50.0 (1.969")	65.0 (2.559")	80.0 (3.150")	95.0 (3.740")
Ref. Length (L1) [mm]	42.0 (1.654")	15.0 (0.591")	15.0 (0.591")	15.0 (0.591")
Ref. Width (L2) [mm]	15.0 (0.591")	19.0 (0.748")	19.0 (0.748")	19.0 (0.748")
Ref. Width (L3) [mm]	10.0 (0.394")	10.0 (0.394")	10.0 (0.394")	10.0 (0.394")
Width (W) [mm]	37.0 (1.457")	37.0 (1.457")	37.0 (1.457")	37.0 (1.457")
Ref. Width (W1) [mm]	16.0 (0.630")	16.0 (0.630")	16.0 (0.630")	16.0 (0.630")
Height (H) [mm]	32.5 (1.280")	32.5 (1.280")	32.5 (1.280")	32.5 (1.280")
Screws	Hexagon Socket Set Screw, M6-1.0 Zinc Plated Steel	Hexagon Socket Set Screw, M6-1.0 Zinc Plated Steel	Hexagon Socket Set Screw, M6-1.0 Zinc Plated Steel	Hexagon Socket Set Screw, M6-1.0 Zinc Plated Steel
Rated Torque [in-lb]	20 in-lb (2.26 Nm)	20 in-lb (2.26 Nm)	20 in-lb (2.26 Nm)	20 in-lb (2.26 Nm)
Quick Connect Size	0.187" x 0.020" Q.C. 4 Tabs	0.187" x 0.020" Q.C. 4 Tabs	0.187" x 0.020" Q.C. 4 Tabs	0.187" x 0.020" Q.C. 4 Tabs
Poles	2	3	4	5
Electrical Specifications				
Rated Voltage [V]	600V	600V	600V	600V
Rated Current [A]	50A	50A	50A	50A
Wire Size (Input / Output) [AWG]	#16-6 / #20-14 AWG	#16-6 / #20-14 AWG	#16-6 / #20-14 AWG	#16-6 / #20-14 AWG
Wire Size (Input / Output) [mm ²]	1.3-13.0 / 0.5-2.0mm ²	1.3-13.0 / 0.5-2.0mm ²	1.3-13.0 / 0.5-2.0mm ²	1.3-13.0 / 0.5-2.0mm ²
Materials				
Base Materials	PBT	PBT	PBT	PBT
Color	BLACK	BLACK	BLACK	BLACK
Flame Retarded Grade	UL 94V-0	UL 94V-0	UL 94V-0	UL 94V-0
Certification	UL/cUL E235927	UL/cUL E235927	UL/cUL E235927	UL/cUL E235927

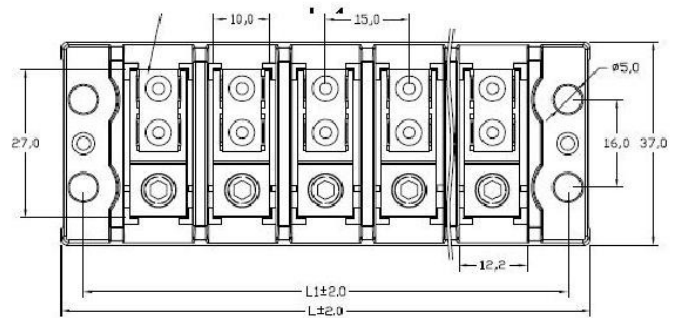
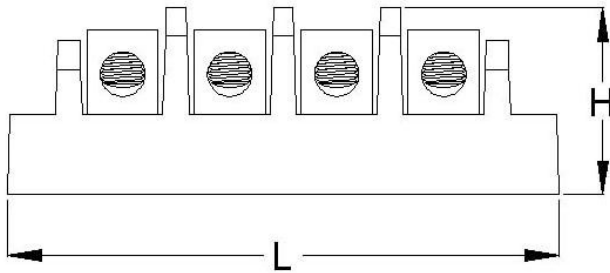

POWER DISTRIBUTION TERMINAL BLOCKS (TGP-050)

(TGP-050), A Type







Product	TGP-050-06A	TGP-050-07A	TGP-050-08A	TGP-050-09A
Specifications				
Total Length (L) [mm]	110.0 (4.331")	125.0 (4.921")	140.0 (5.512")	155.0 (6.102")
Ref. Length (L1) [mm]	102.0 (4.106")	117.0 (4.606")	132.0 (5.197")	147.0 (5.787")
Ref. Width (L2) [mm]	15.0 (0.591")	15.0 (0.591")	15.0 (0.591")	15.0 (0.591")
Ref. Width (L3) [mm]	10.0 (0.394")	10.0 (0.394")	10.0 (0.394")	10.0 (0.394")
Width (W) [mm]	37.0 (1.457")	37.0 (1.457")	37.0 (1.457")	37.0 (1.457")
Ref. Width (W1) [mm]	16.0 (0.630")	16.0 (0.630")	16.0 (0.630")	16.0 (0.630")
Height (H) [mm]	32.5 (1.280")	32.5 (1.280")	32.5 (1.280")	32.5 (1.280")
Screws	Hexagon Socket Set Screw, M6-1.0 Zinc Plated Steel	Hexagon Socket Set Screw, M6-1.0 Zinc Plated Steel	Hexagon Socket Set Screw, M6-1.0 Zinc Plated Steel	Hexagon Socket Set Screw, M6-1.0 Zinc Plated Steel
Rated Torque [in-lb]	20 in-lb (2.26 Nm)	20 in-lb (2.26 Nm)	20 in-lb (2.26 Nm)	20 in-lb (2.26 Nm)
Quick Connect Size	0.187" x 0.020" Q.C. 4 Tabs	0.187" x 0.020" Q.C. 4 Tabs	0.187" x 0.020" Q.C. 4 Tabs	0.187" x 0.020" Q.C. 4 Tabs
Poles	6	7	8	9
Electrical Specifications				
Rated Voltage [V]	600V	600V	600V	600V
Rated Current [A]	50A	50A	50A	50A
Wire Size (Input / Output) [AWG]	#16-6 / #20-14 AWG	#16-6 / #20-14 AWG	#16-6 / #20-14 AWG	#16-6 / #20-14 AWG
Wire Size (Input / Output) [mm ²]	1.3-13.0 / 0.5-2.0mm ²	1.3-13.0 / 0.5-2.0mm ²	1.3-13.0 / 0.5-2.0mm ²	1.3-13.0 / 0.5-2.0mm ²
Materials				
Base Materials	PBT	PBT	PBT	PBT
Color	BLACK	BLACK	BLACK	BLACK
Flame Retarded Grade	UL 94V-0	UL 94V-0	UL 94V-0	UL 94V-0
Certification	UL/cUL E235927	UL/cUL E235927	UL/cUL E235927	UL/cUL E235927

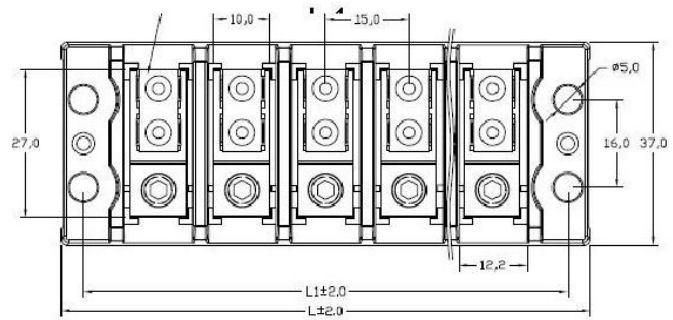
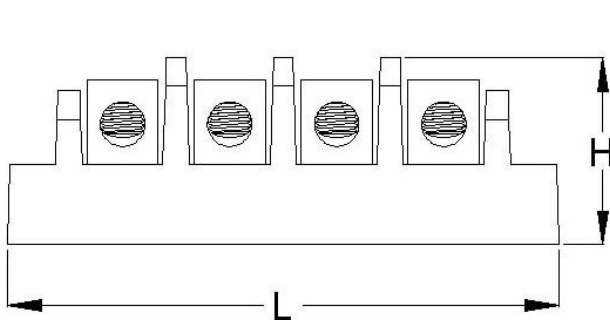

POWER DISTRIBUTION TERMINAL BLOCKS (TGP-050)

(TGP-050), A Type



Product	TGP-050-10A	TGP-050-11A	TGP-050-12A
Specifications			
Total Length (L) [mm]	170.0 (6.693")	185.0 (7.283")	200.0 (7.874")
Ref. Length (L1) [mm]	162.0 (6.378")	177.0 (6.969")	192.0 (7.559")
Ref. Width (L2) [mm]	15.0 (0.591")	15.0 (0.591")	15.0 (0.591")
Ref. Width (L3) [mm]	10.0 (0.394")	10.0 (0.394")	10.0 (0.394")
Width (W) [mm]	37.0 (1.457")	37.0 (1.457")	37.0 (1.457")
Ref. Width (W1) [mm]	16.0 (0.630")	16.0 (0.630")	16.0 (0.630")
Height (H) [mm]	32.5 (1.280")	32.5 (1.280")	32.5 (1.280")
Screws	Hexagon Socket Set Screw, M6-1.0 Zinc Plated Steel	Hexagon Socket Set Screw, M6-1.0 Zinc Plated Steel	Hexagon Socket Set Screw, M6-1.0 Zinc Plated Steel
Rated Torque [in-lb]	20 in-lb (2.26 Nm)	20 in-lb (2.26 Nm)	20 in-lb (2.26 Nm)
Quick Connect Size	0.187" x 0.020" Q.C. 4 Tabs	0.187" x 0.020" Q.C. 4 Tabs	0.187" x 0.020" Q.C. 4 Tabs
Poles	10	11	12
Electrical Specifications			
Rated Voltage [V]	600V	600V	600V
Rated Current [A]	50A	50A	50A
Wire Size (Input / Output) [AWG]	#16-6 / #20-14 AWG	#16-6 / #20-14 AWG	#16-6 / #20-14 AWG
Wire Size (Input / Output) [mm ²]	1.3-13.0 / 0.5-2.0mm ²	1.3-13.0 / 0.5-2.0mm ²	1.3-13.0 / 0.5-2.0mm ²
Materials			
Base Materials	PBT	PBT	PBT
Color	BLACK	BLACK	BLACK
Flame Retarded Grade	UL 94V-0	UL 94V-0	UL 94V-0
Certification	UL/cUL E235927	UL/cUL E235927	UL/cUL E235927



POWER DISTRIBUTION TERMINAL BLOCKS (TGP-050)

(TGP-050), A1 Type

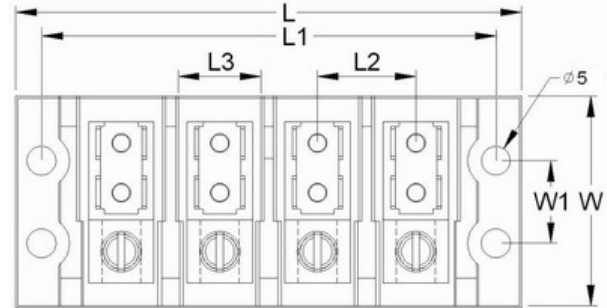
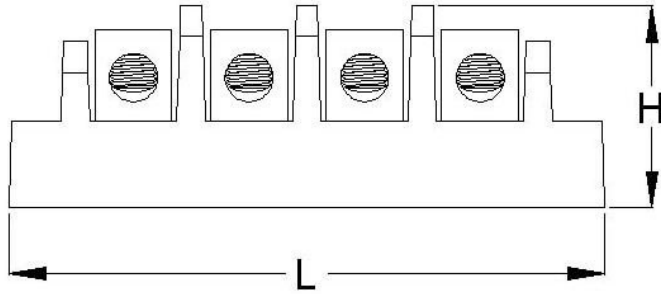

Product

TGP-050-02A1

TGP-050-03A1

TGP-050-04A1

TGP-050-05A1

Specifications







Total Length (L) [mm]	50.0 (1.969")	65.0 (2.559")	80.0 (3.150")	95.0 (3.740")
Ref. Length (L1) [mm]	42.0 (1.654")	15.0 (0.591")	15.0 (0.591")	15.0 (0.591")
Ref. Width (L2) [mm]	15.0 (0.591")	19.0 (0.748")	19.0 (0.748")	19.0 (0.748")
Ref. Width (L3) [mm]	10.0 (0.394")	10.0 (0.394")	10.0 (0.394")	10.0 (0.394")
Width (W) [mm]	37.0 (1.457")	37.0 (1.457")	37.0 (1.457")	37.0 (1.457")
Ref. Width (W1) [mm]	16.0 (0.630")	16.0 (0.630")	16.0 (0.630")	16.0 (0.630")
Height (H) [mm]	32.5 (1.280")	32.5 (1.280")	32.5 (1.280")	32.5 (1.280")
Screws	Slotted Set Screw, M6-1.0 Zinc Plated Steel	Slotted Set Screw, M6-1.0 Zinc Plated Steel	Slotted Set Screw, M6-1.0 Zinc Plated Steel	Slotted Set Screw, M6-1.0 Zinc Plated Steel
Rated Torque [in-lb]	20 in-lb (2.26 Nm)	20 in-lb (2.26 Nm)	20 in-lb (2.26 Nm)	20 in-lb (2.26 Nm)
Quick Connect Size	0.187" x 0.020" Q.C. 4 Tabs	0.187" x 0.020" Q.C. 4 Tabs	0.187" x 0.020" Q.C. 4 Tabs	0.187" x 0.020" Q.C. 4 Tabs
Poles	2	3	4	5
Electrical Specifications				
Rated Voltage [V]	600V	600V	600V	600V
Rated Current [A]	50A	50A	50A	50A
Wire Size (Input / Output) [AWG]	#16-6 / #20-14 AWG	#16-6 / #20-14 AWG	#16-6 / #20-14 AWG	#16-6 / #20-14 AWG
Wire Size (Input / Output) [mm ²]	1.3-13.0 / 0.5-2.0mm ²	1.3-13.0 / 0.5-2.0mm ²	1.3-13.0 / 0.5-2.0mm ²	1.3-13.0 / 0.5-2.0mm ²
Materials				
Base Materials	PBT	PBT	PBT	PBT
Color	BLACK	BLACK	BLACK	BLACK
Flame Retarded Grade	UL 94V-0	UL 94V-0	UL 94V-0	UL 94V-0
Certification	UL/cUL E235927	UL/cUL E235927	UL/cUL E235927	UL/cUL E235927

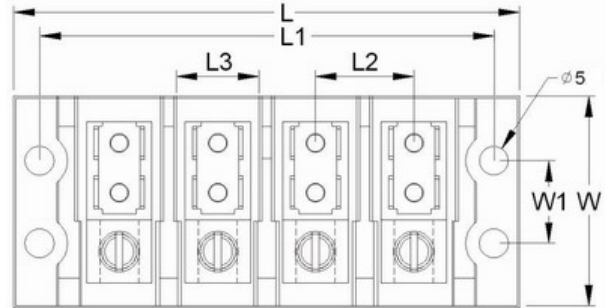
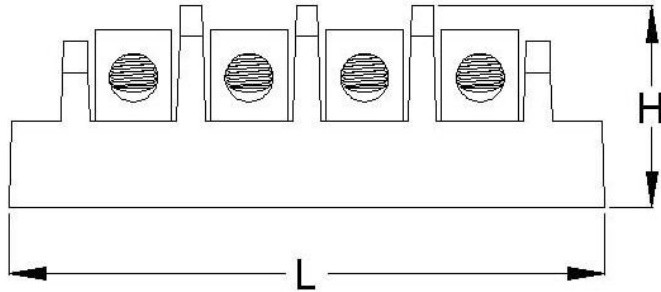

POWER DISTRIBUTION TERMINAL BLOCKS (TGP-050)

(TGP-050), A1 Type







Product	TGP-050-06A1	TGP-050-07A1	TGP-050-08A1	TGP-050-09A1
Specifications				
Total Length (L) [mm]	110.0 (4.331")	125.0 (4.921")	140.0 (5.512")	155.0 (6.102")
Ref. Length (L1) [mm]	102.0 (4.106")	117.0 (4.606")	132.0 (5.197")	147.0 (5.787")
Ref. Width (L2) [mm]	15.0 (0.591")	15.0 (0.591")	15.0 (0.591")	15.0 (0.591")
Ref. Width (L3) [mm]	10.0 (0.394")	10.0 (0.394")	10.0 (0.394")	10.0 (0.394")
Width (W) [mm]	37.0 (1.457")	37.0 (1.457")	37.0 (1.457")	37.0 (1.457")
Ref. Width (W1) [mm]	16.0 (0.630")	16.0 (0.630")	16.0 (0.630")	16.0 (0.630")
Height (H) [mm]	32.5 (1.280")	32.5 (1.280")	32.5 (1.280")	32.5 (1.280")
Screws	Slotted Set Screw, M6-1.0 Zinc Plated Steel	Slotted Set Screw, M6-1.0 Zinc Plated Steel	Slotted Set Screw, M6-1.0 Zinc Plated Steel	Slotted Set Screw, M6-1.0 Zinc Plated Steel
Rated Torque [in-lb]	20 in-lb (2.26 Nm)	20 in-lb (2.26 Nm)	20 in-lb (2.26 Nm)	20 in-lb (2.26 Nm)
Quick Connect Size	0.187" x 0.020" Q.C. 4 Tabs	0.187" x 0.020" Q.C. 4 Tabs	0.187" x 0.020" Q.C. 4 Tabs	0.187" x 0.020" Q.C. 4 Tabs
Poles	6	7	8	9
Electrical Specifications				
Rated Voltage [V]	600V	600V	600V	600V
Rated Current [A]	50A	50A	50A	50A
Wire Size (Input / Output) [AWG]	#16-6 / #20-14 AWG	#16-6 / #20-14 AWG	#16-6 / #20-14 AWG	#16-6 / #20-14 AWG
Wire Size (Input / Output) [mm ²]	1.3-13.0 / 0.5-2.0mm ²	1.3-13.0 / 0.5-2.0mm ²	1.3-13.0 / 0.5-2.0mm ²	1.3-13.0 / 0.5-2.0mm ²
Materials				
Base Materials	PBT	PBT	PBT	PBT
Color	BLACK	BLACK	BLACK	BLACK
Flame Retarded Grade	UL 94V-0	UL 94V-0	UL 94V-0	UL 94V-0
Certification	UL/cUL E235927	UL/cUL E235927	UL/cUL E235927	UL/cUL E235927

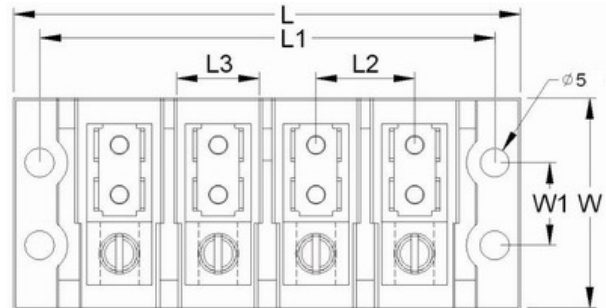
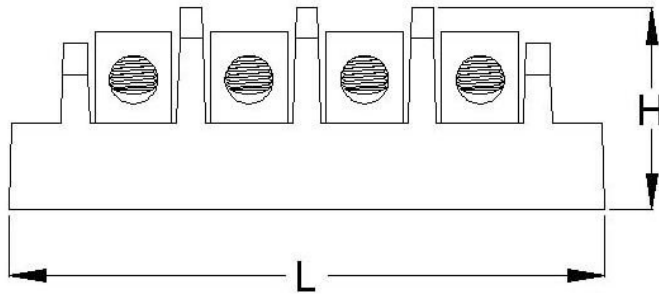

POWER DISTRIBUTION TERMINAL BLOCKS (TGP-050)

(TGP-050), A1 Type



Product	TGP-050-10A1	TGP-050-11A1	TGP-050-12A1
Specifications			
Total Length (L) [mm]	170.0 (6.693")	185.0 (7.283")	200.0 (7.874")
Ref. Length (L1) [mm]	162.0 (6.378")	177.0 (6.969")	192.0 (7.559")
Ref. Width (L2) [mm]	15.0 (0.591")	15.0 (0.591")	15.0 (0.591")
Ref. Width (L3) [mm]	10.0 (0.394")	10.0 (0.394")	10.0 (0.394")
Width (W) [mm]	37.0 (1.457")	37.0 (1.457")	37.0 (1.457")
Ref. Width (W1) [mm]	16.0 (0.630")	16.0 (0.630")	16.0 (0.630")
Height (H) [mm]	32.5 (1.280")	32.5 (1.280")	32.5 (1.280")
Screws	Slotted Set Screw, M6-1.0 Zinc Plated Steel	Slotted Set Screw, M6-1.0 Zinc Plated Steel	Slotted Set Screw, M6-1.0 Zinc Plated Steel
Rated Torque [in-lb]	20 in-lb (2.26 Nm)	20 in-lb (2.26 Nm)	20 in-lb (2.26 Nm)
Quick Connect Size	0.187" x 0.020" Q.C. 4 Tabs	0.187" x 0.020" Q.C. 4 Tabs	0.187" x 0.020" Q.C. 4 Tabs
Poles	10	11	12
Electrical Specifications			
Rated Voltage [V]	600V	600V	600V
Rated Current [A]	50A	50A	50A
Wire Size (Input / Output) [AWG]	#16-6 / #20-14 AWG	#16-6 / #20-14 AWG	#16-6 / #20-14 AWG
Wire Size (Input / Output) [mm ²]	1.3-13.0 / 0.5-2.0mm ²	1.3-13.0 / 0.5-2.0mm ²	1.3-13.0 / 0.5-2.0mm ²
Materials			
Base Materials	PBT	PBT	PBT
Color	BLACK	BLACK	BLACK
Flame Retarded Grade	UL 94V-0	UL 94V-0	UL 94V-0
Certification	UL/cUL E235927	UL/cUL E235927	UL/cUL E235927